



Estimate

Number

E695

Date

8/14/2024

Customer:

240057 STOCK
28' Vintage Trailer

Description	Price	Quantity	Total
28' Pro Stock Tandem 5,200# Axles P828T25	\$18,430.00		\$18,430.00
Aluminum Pull Out Step - 40" for 48" Garage Door	\$308.00		\$308.00
Exterior Speakers - Pair	\$93.00		\$93.00
Soundbar w/subwoofer	\$204.00		\$204.00
36" X 30" Generator Door w/ Vent (Incl CO2 & Smoke Det)	\$248.00		\$248.00
60" Triple Tube Tongue	\$160.00		\$160.00
D-Ring Floor - Installed	\$22.00	8.00	\$176.00
Roof Vent	\$49.00		\$49.00
235 R16 Aluminum 6 Lug ipo 15" Aluminum Pro Stock	\$71.00	4.00	\$284.00
235 R16 Silver Spoke - Spare	\$180.00	1.00	\$180.00
Inside Spare Tire Mount	\$49.00	1.00	\$49.00
Winch & 12V Battery	\$1,140.00		\$1,140.00
Cut Out in Cabinet for Winch	\$28.00		\$28.00
3500# Electric Tongue Jack	\$327.00		\$327.00
Transition Flap	\$93.00		\$93.00
Upgrade Ext. Metal to Medium Charcoal Gry	\$11.00	28.00	\$308.00
36" Indoor/Outdoor Carpet on Walls Pro Stock	\$12.00	28.00	\$336.00
Heavy Duty Skid Wheels Pair	\$123.00		\$123.00
Recessed Spare Tire Compartment w/ Hinged Lid	\$246.00		\$246.00



Estimate

Number

E695

Date

8/14/2024

Customer:

240057 STOCK
28' Vintage Trailer

Description	Price	Quantity	Total
Upgrade to colored Metal Int. Walls PMF Silver Frost	\$4.00	28.00	\$112.00
12V Wall Switch	\$16.00		\$16.00
LED Light 14" x 3-1/2" (Under Overhead)	\$99.00		\$99.00
5 Drawer Toolbox - Ball Bearing	\$493.00		\$493.00
MATERIAL SURCHARGE (Winter Special)	\$8,997.00		\$8,997.00
PRI Show Discount	(\$500.00)		(\$500.00)
Factory Delivery to Marengo	\$300.00		\$300.00
DISCOUNT	(\$5,500.00)		(\$5,500.00)

Shipping Cost





\$0.00



Sub Total

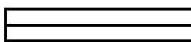



\$26,799.00



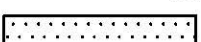
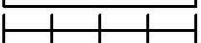

Total

\$26,799.00

-  4' Fluor Light
-  12v Light
-  Quartz Light
-  110v Recept

-  Switch
-  Ethernet Cable
-  Recessed E-Track
-  Surface E-Track

-  Air Inlet
-  Air Outlet
-  Spare Tire Mount
-  D-Ring

-  Speaker
-  LED Scene Light
-  20 Amp Recept
-  20 Amp Switch

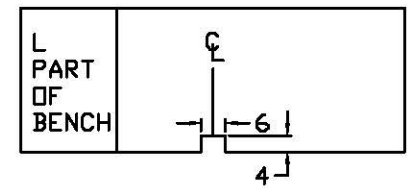
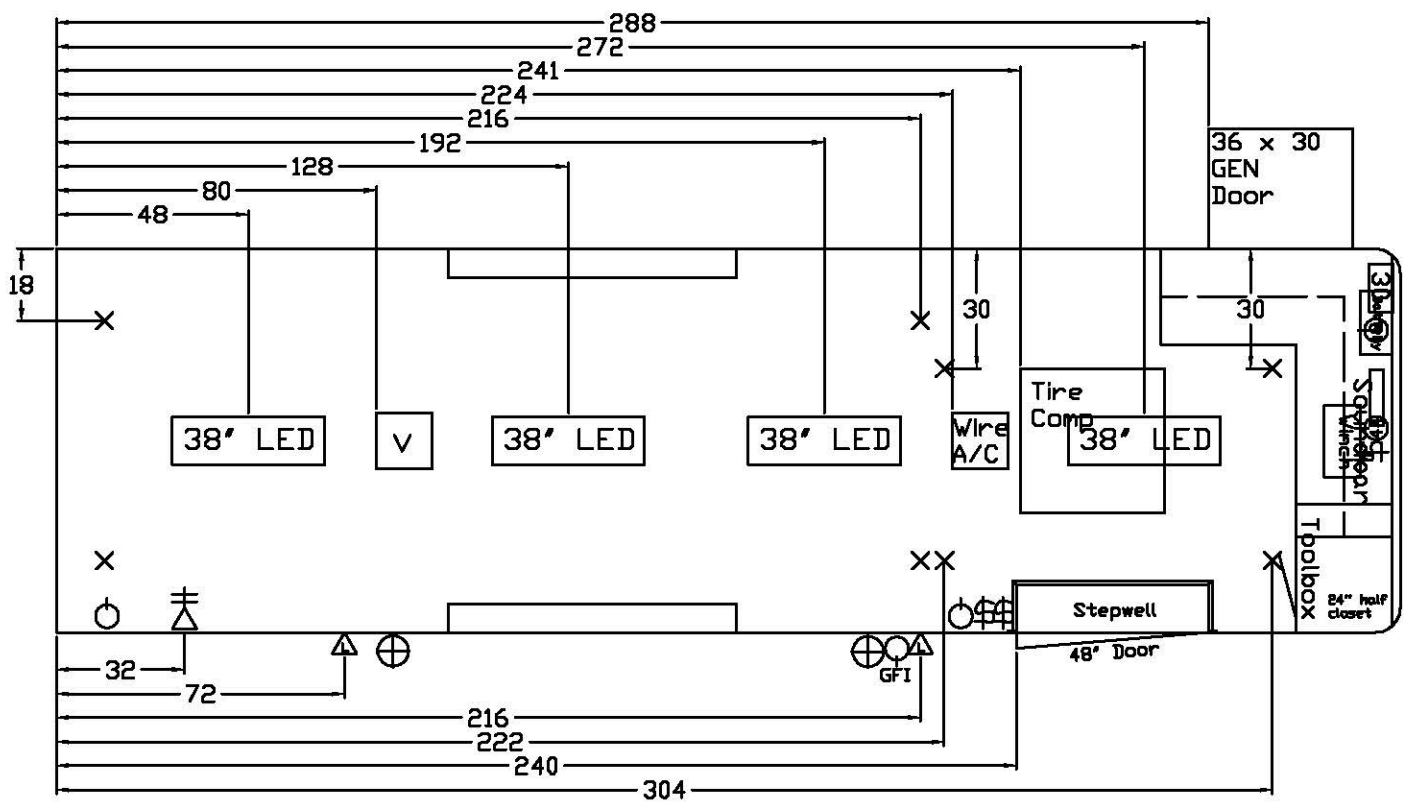

Vintage Trailers Ltd.
PRO STOCK

Dealer: WESTSIDE
Model: QL828
Serial #: 240057
Customer:

Salesman: TODD KUJAWA
Date: 12/4/23
Revision Date: None
Page: 1 of 1 Scale: 1/4" = 1'

Please Review, Sign, Date, and Return Sign
Date:

PRO STOCK STANDARD EQUIPMENT

Interior Height		6'6"
Interior Width		96"
Exterior Aluminum		.040" Smooth Side
Wheels		Goodyear Radials (Except G Tires) on Aluminum Wheels
Frame		Painted / Z-Tech Undercoating
Tag		2" x 6" Tube - 4 Foot Beavertail
Gooseneck		2"x 8" Tube - 4 Foot Beavertail
Torsion Axles		Dexter E-Z Lube Axles - All Wheel Electric Brakes 82" Between Wheel Wells
Wall Construction		1" x 1 1/2" Steel Tube
16" Centers		Walls, Ceiling & Floor
Flooring		3/4" Plywood with Darco Moisture Barrier TPO Coin Flooring
Ceiling & Walls		White Vinyl Ceiling and Screwless .030" Aluminum Walls
Insulation		Ceiling
Side Door		48" with Flush Lock and Deadbolt - Piano Hinge
Side Door Construction		Aluminum Tube
Ramp Door		Spring Assist with Single Handle Recessed Latch ATP on Ramp Door 16" Wide Aluminum Flap Brite Annodized Rear Hoop
Spring Cover		White Aluminum
Roof		1 Pc. Aluminum w Roof Vent Wired for A/C
Radius Corner		Polished Cast Aluminum Corners & Stainless Steel Cap
Clearance Lights		L.E.D.
Electrical		(4) 38" LED Flat Panel Lights w/ 1 Switch (2) Destin LED Scene Lights w/ 1 Switch (3) Interior Recepts. (1) GFI Recept 45 amp Smart Charger, 30 amp Load center w/ Lifeline
Cabinets	Tag	L-Shape Workbench, 16" L-Shape Overhead & 24" Closet
	GN	L-Shape Workbench, 16" Straight Overhead & 24" Closet
Tail Lights		L.E.D. in Uprights & L.E.D. License Plate Light
Stoneguard		ATP Tag - ATP Gooseneck
Jack	GN	Single Hydraulic Jack with Battery (Goosneck Only)
Wheel Wells		Covered in ATP
Warranty		3 Year Factory Warranty























Custom Race Trailers



CALL KELLY



(815) 529-2647

Family Ran Business